

Jägerhochsitz mit Futtergrippe



Raised hide with crib

Mirador avec râtelier à fourrage

Art. Nr. 331848

- D**
- Verwenden Sie nur POLA G-Cement.
 - Machen Sie sich vor dem Zusammenbau gut mit den Einzelteilen des Bausatzes vertraut.
 - Trennen Sie die Einzelteile erst dann ab, wenn sie gebraucht werden.
 - Verwenden Sie beim Zusammenbau wenig Klebstoff.
 - Sie werden dann mehr Freude an einem sauberem Modell haben.
 - Sollte trotz werkseitiger sorgfältiger Prüfung ein Teil fehlen oder fehlerhaft sein, kreuzen Sie bitte das Teil in der Anleitung an und schicken Sie diese bitte an **POLA-Vertrieb:**
Gebr. FALLER GmbH, Abt. Kundendienst, Kreuzstraße 9, D-78148 Gütenbach.
Sie erhalten dann umgehend Ersatz.
- GB**
- Use POLA G-Cement only.
 - Familiarize yourself well with the components of the kit before assembly.
 - Do not break off the components until the moment you need them.
 - Use glue sparingly on assembly, then you will enjoy your neat model even more.
 - If a part is missing or defective despite careful checking at the factory, please mark the part concerned in your instructions and send it to:
POLA-Vertrieb:
Gebr. FALLER GmbH, Abt. Kundendienst, Kreuzstraße 9,
D-78148 Gütenbach, Germany.
You will receive replacement promptly.
- F**
- N'utilisez que la colle POLA G -Cement.
 - Avant l'assemblage, familiarisez vous avec les différentes pièces du jeu de construction.
 - Ne séparer les pièces particulières qu'au moment de les utiliser.
 - Utiliser aussi peu de colle que possible pour l'assemblage, vous aurez d'autant plus de plaisir avec un modèle propre.
 - Si, malgré un contrôle soigneux à l'usine, une pièce devait manquer ou être défectueuse, marquer cette pièce d'une croix dans les instructions et envoyer ces dernières à:
POLA-Vertrieb:
Gebr. FALLER GmbH, Abt. Kundendienst, Kreuzstraße 9,
D-78148 Gütenbach (R.F.A.).
On vous la remplacera aussitôt.



Sa. Nr. 406 837 0

2

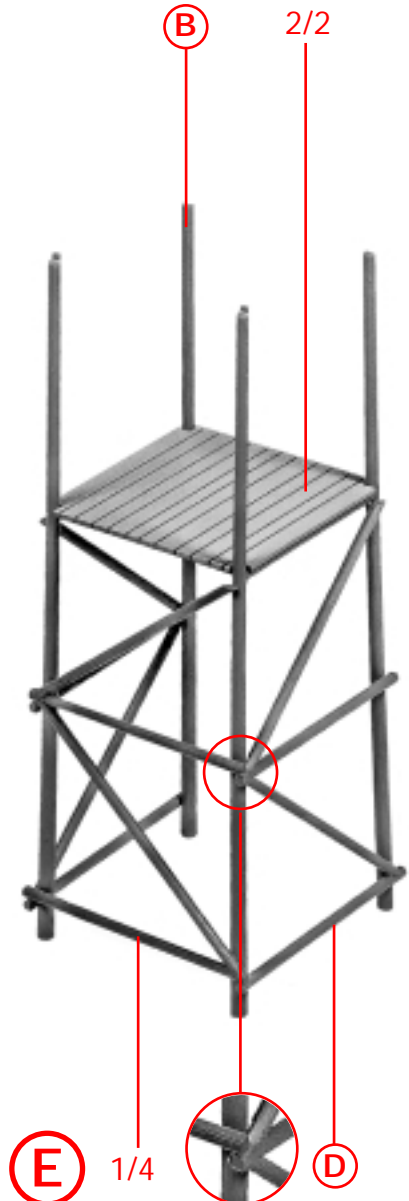
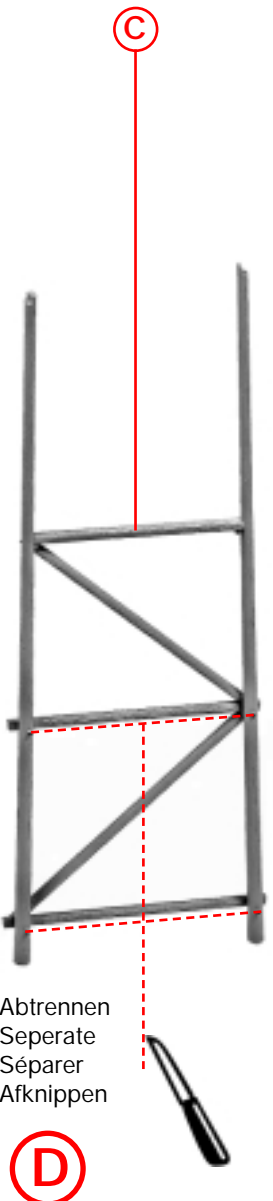
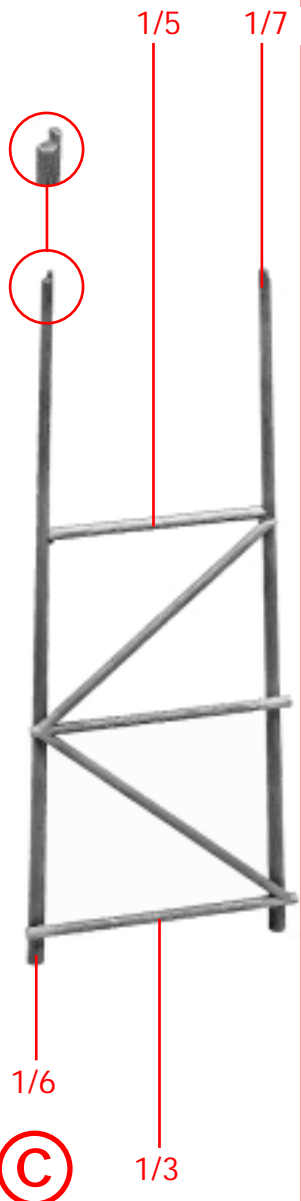
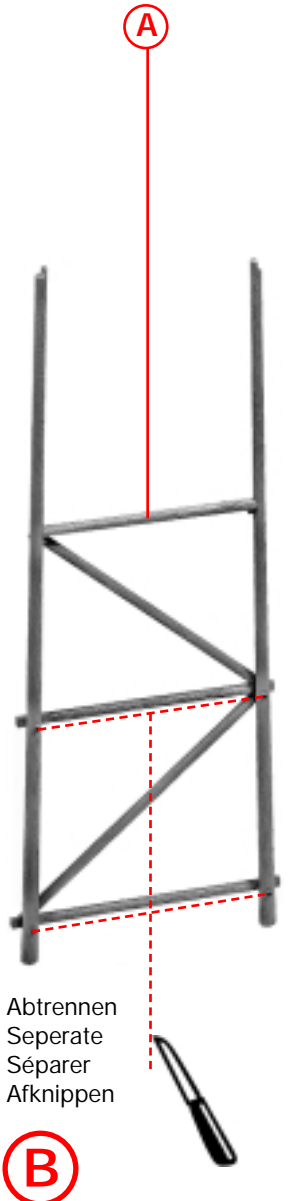
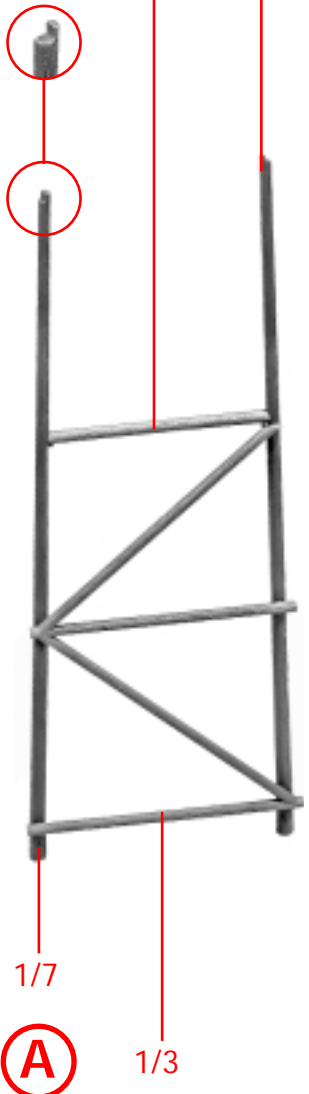

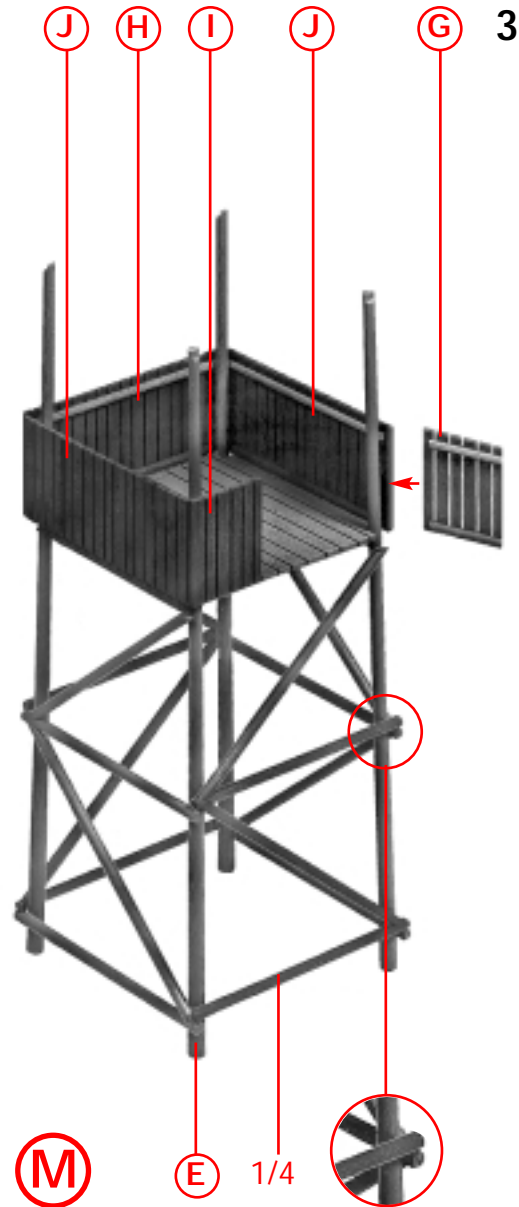
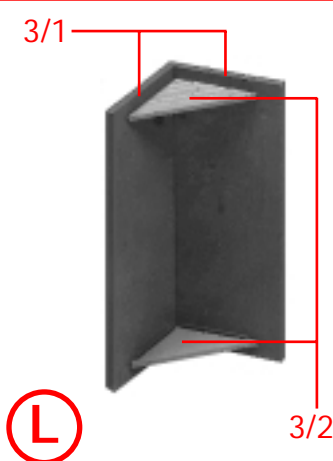
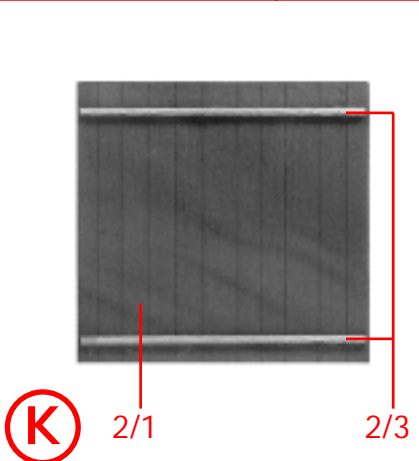
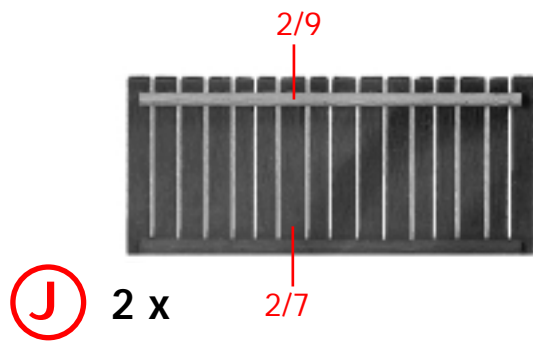
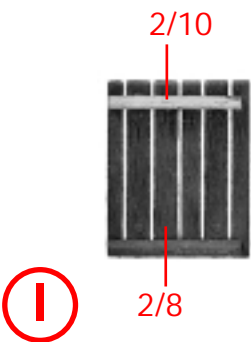
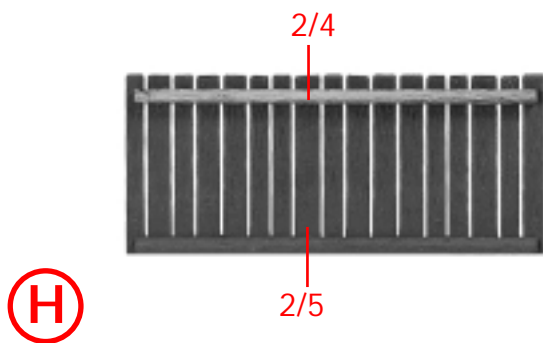
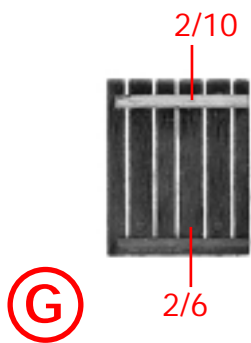
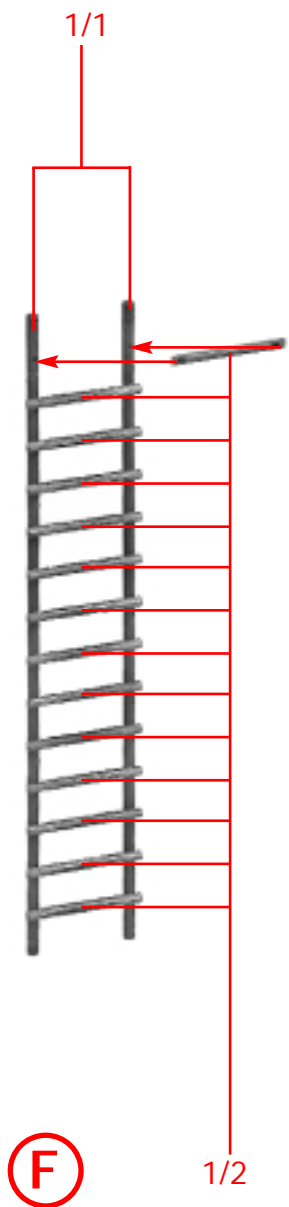

4

(K)

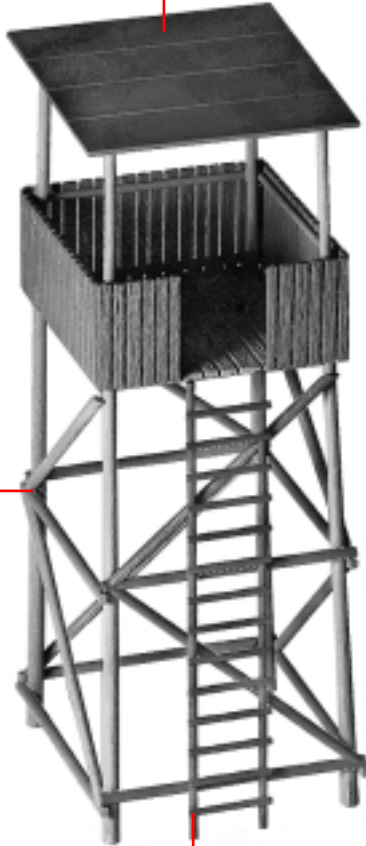

(M)

(N)

(F)

3/4

3/8

3/3

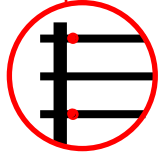

(O)

3/4

3/8

3/3

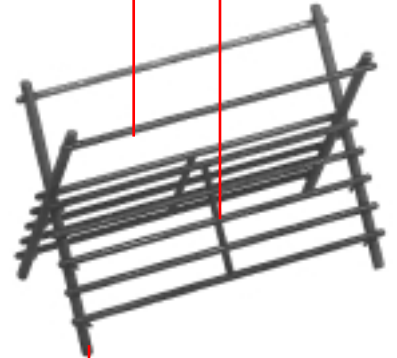

(P)

(O)

3/5

(P)

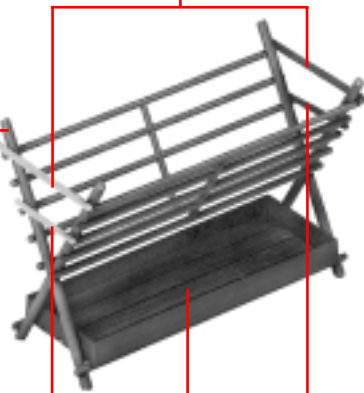

(Q)

3/6

3/7

3/6

(L)

(Q)

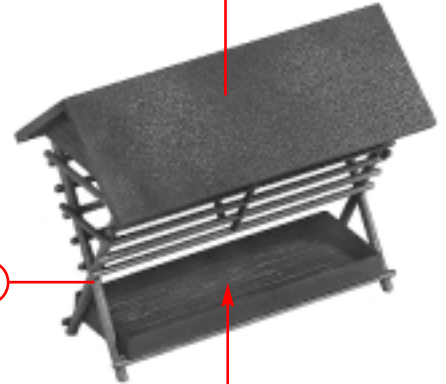

(R)

Inhalt	Tüte	Contenu	sachet
Contents	bag	Inhoud	zakje